

SONY[®]

NTSC

3-CCD Color Video Camera

DXC-9000



Progressive 3CCD

The DXC-9000

Experience the Benefits of
a Sony 3-Chip
Progressive Scan
CCD Color Camera

Amusement Park

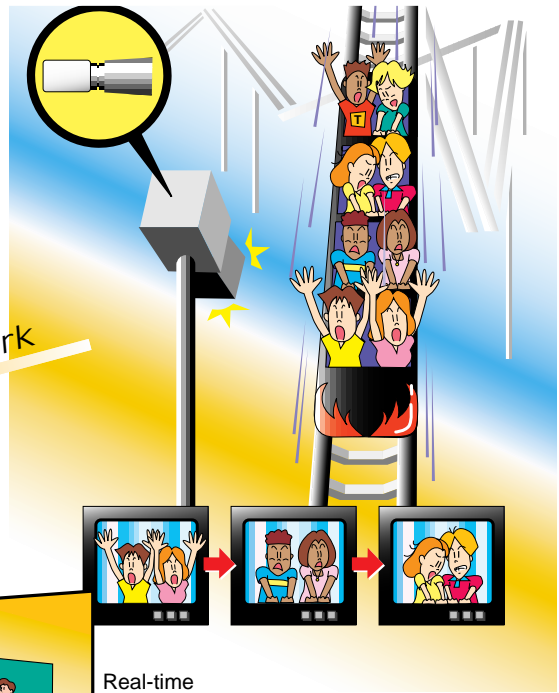

Real-time transmission

Real-time transmission

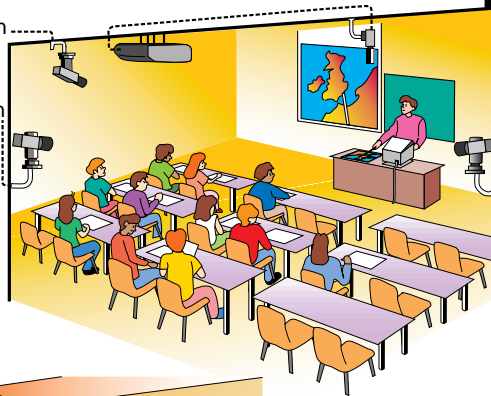

Real-time transmission

Distance Learning

Video Microscopy

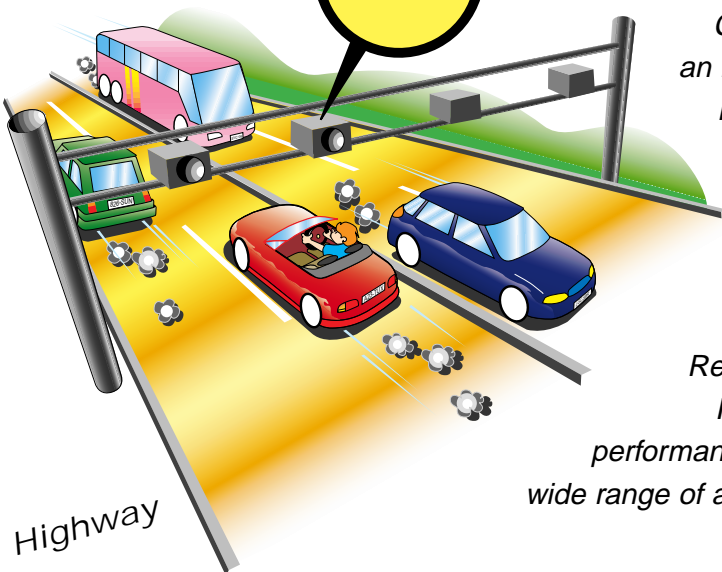
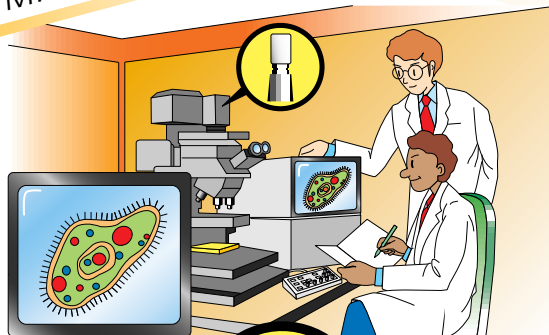

Highway

The DXC-9000 is a revolutionary, compact 1/2-inch three-CCD color video camera. Thanks to Progressive Scan technology, this camera captures objects moving at high speeds and produces clear images with high horizontal and vertical resolution.

Thanks to the built-in memory, the DXC-9000 provides three types of output signals, including VGA. The field and frame output signals allow the camera to maintain complete system compatibility with existing video equipment. In addition, the new CCD utilizes square pixels, making the DXC-9000 an ideal camera for computerized image processing.

Moreover, operational convenience is significantly enhanced by special features such as Freeze control, built-in long term exposure and an external trigger shutter function. All functions can be easily controlled from either the camera's rear panel, the optional RM-C950 Remote Control Unit or an external computer via an RS-232C connection. Offering outstanding picture performance, the DXC-9000 creates a new opportunity in a wide range of applications including computer imaging, scientific research and industrial inspection.

Progressive Scan 3-CCD

As the world-first challenge in the industrial color camera field, Sony has employed three chips of 1/2-inch Progressive Scan CCDs for the DXC-9000 in great success. By using the Progressive Scan CCDs, the DXC-9000 outputs all the electric charges accumulated every 1/60 second, to provide a complete frame.

Conventional CCDs use half of the electric charges taken from one image every 1/60 second to form an odd field, and half the electric charges taken from the next image, 1/60 second later, to form one frame. As a result of using Progressive Scan CCDs combined with a frame memory, the DXC-9000 can capture

a full frame image within a period of 1/60 second to provide a high vertical and high dynamic resolution image. This enables the camera to provide blur-free, clear images of fast-moving objects without a mechanical shutter.

Still Image Capture Three Different Methods

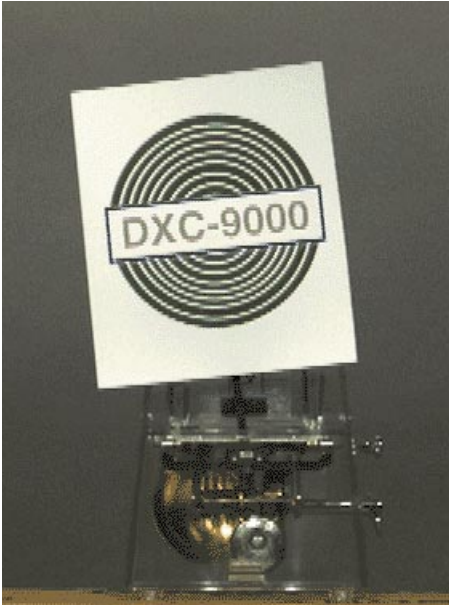

• Conventional CCD - Field integration mode (60 fields, interlaced)

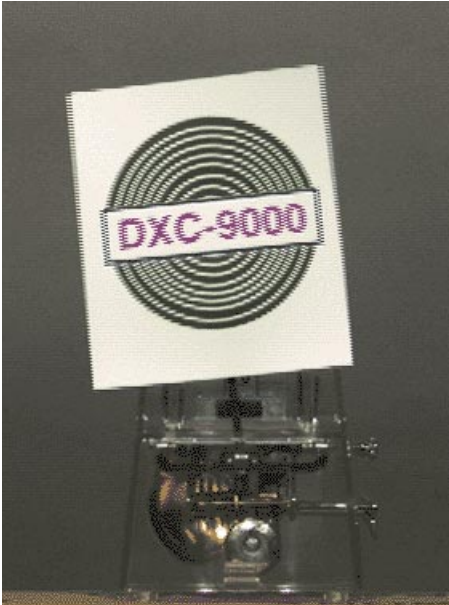

• Conventional CCD - Frame integration mode (30 frames, interlaced)

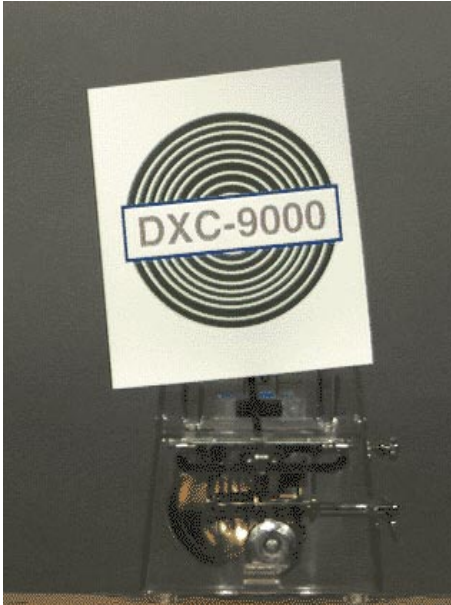

• Progressive Scan CCD - DXC-9000, frame shutter mode (30 frames, interlaced)

Note: This object was attached on a metronome. The movement of the objects were taken under the same conditions.

Square Picture Pixels Adoption , 9.9μm x 9.9μm

The CCD of the DXC-9000 is composed of square pixels, 9.9μm x 9.9μm, so that an adjustment of the aspect ratio is not required when the image is captured and manipulated in a computer. As a result, an accurate picture without distortion can be obtained, which enables the image to be easily calculated in the computer.

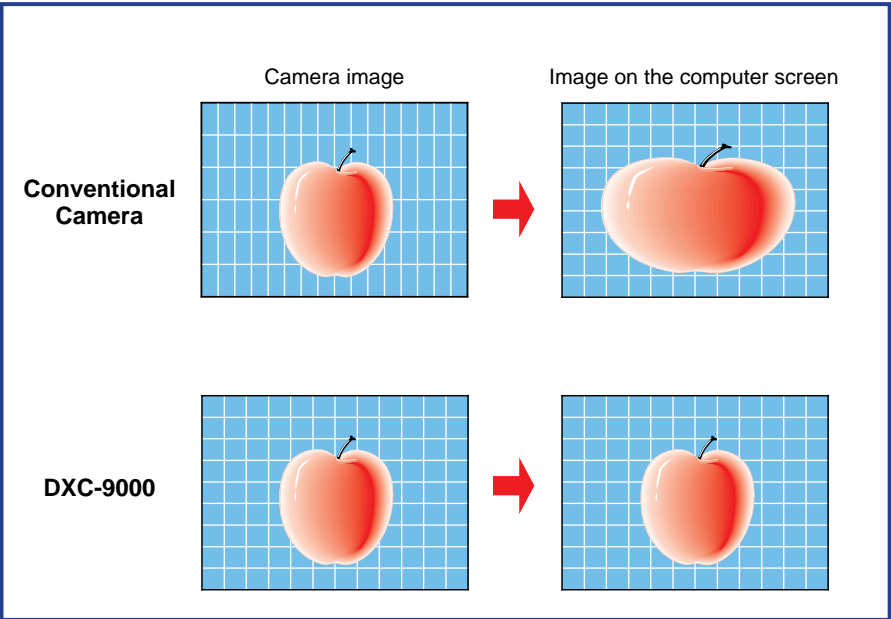

Three Types of Output System

The DXC-9000 has a built-in memory so that a frame (two fields) image can be stored. By selecting or combining the image data in the memory, the following outputs are available.

2:1 Interlace Scanning System



Normal mode (NTSC standard) (RGB, Y/C, VBS)

The odd field is provided from one image in 1/60 second and the even field is provided from the next image 1/60 second later. The odd and even field are output one after another, then interlaced together to form one frame. This is the traditional scanning method used in NTSC color cameras.

Frame Shutter Mode (NTSC standard) (RGB, Y/C, VBS)

Both the odd and even field are taken from the same image in 1/60 second. The even field is put in the memory and output after the odd field, then interlaced together, in accordance with the 2/1 interlace scanning system. Even when a high-speed moving object is shot, each frame image is clear, because both the odd field and the following even field are from the same image.

Non-interlace Scanning System



VGA mode (VGA format, 640 x 480) (RGB only)

A VGA signal, using RGB output, can be used with various computer

display devices in a non-interlace scanning system. In the VGA mode, both the odd and even field are output from the DXC-9000 within 1/60 second. This is possible by increasing the horizontal scan rate. With the VGA output, high-quality pictures without blur can be displayed on multi-scan displays and multi-scan printers. The superiority of the VGA output in sharpness and clearness is especially obvious, for example, when shooting small letters typed on a piece of paper or capturing a still image of a fast-moving object. This feature is useful for motion analysis or monitoring images on a projector.

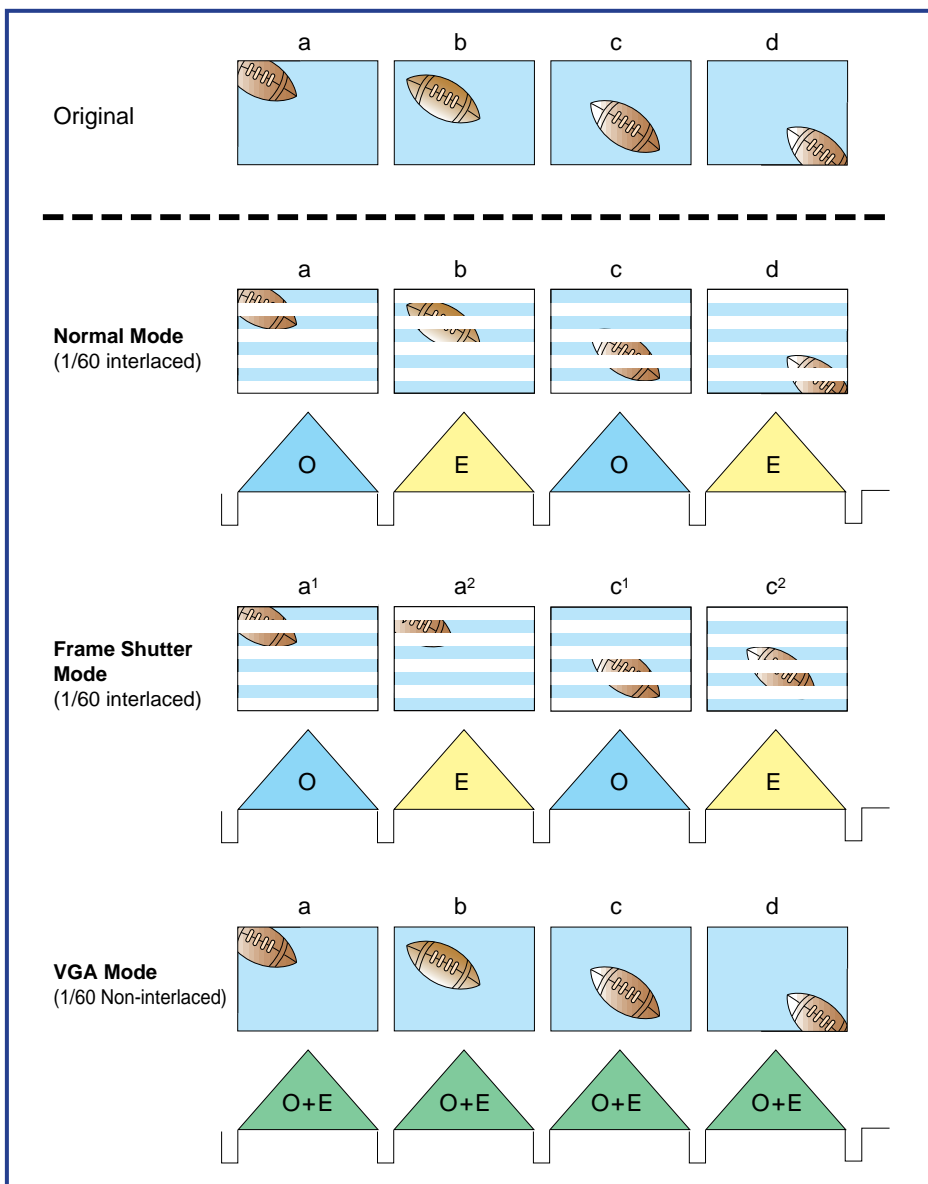

Frame Memory Capability

Utilizing the built-in memory for a still frame, the DXC-9000 provides the following convenient functions.

Freeze function

A moving image can be captured as a still image by just pressing the FREEZE button on the camera's rear panel or the optional RM-C950 Remote Control Unit. Pressing the SOURCE button cancels the freeze mode so that a live image is output.

If necessary, still images can be automatically output by setting the on-screen menu. The following two modes are provided.

Continuous freeze mode

Still images captured in the memory are output continuously.

Source/Freeze mode

Still images and live images are output alternately.

The cycle can be set within the range from 2 frames to 10 minutes. If an external pulse is used, the image can be changed every time the pulse is input.

Long Term Exposure Function

The shutter speed (charge accumulation time) can be selected from 1 to 255 frames in one-frame steps or 15 steps from 0.1 to 8.0 sec*. This provides a remarkable enhancement in sensitivity by accumulating the charge on the CCDs over a longer period than normal. This feature is especially ideal for microscope and surveillance applications because objects in the dark can be clearly captured.

* 0.1, 0.2, 0.3, 0.5, 1.0, 1.5, 2.0, 2.5, 3.0, 4.0, 4.5, 5.0, 6.0, 7.0 and 8.0 sec.

Factory



Gain: 18dB

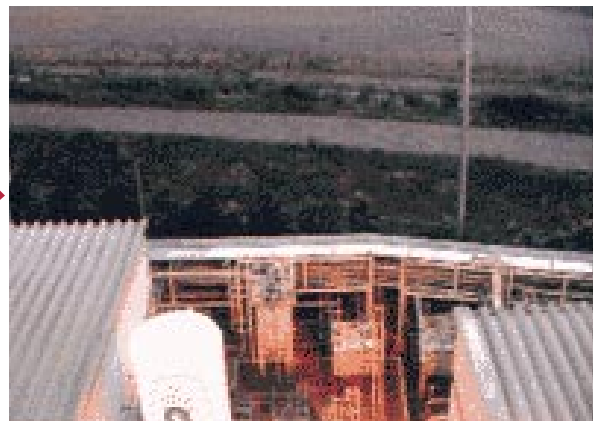

Long Exp: 32 frames

Fluorescent microscope (photo sample: liver of a rat)

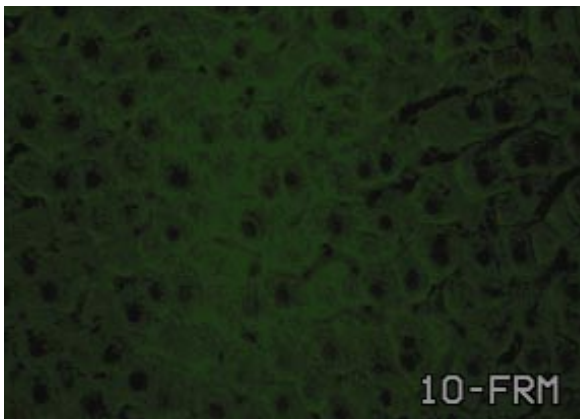

Long Exp: 10 frames

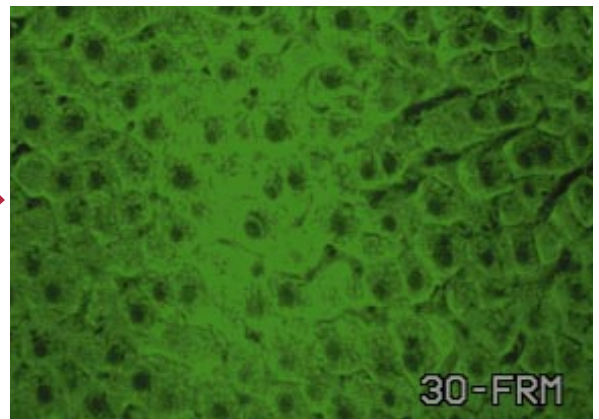

Long Exp: 30 frames

High Picture Quality

The DXC-9000 is equipped with three 1/2-inch IT (Interline Transfer) Hyper HAD™ CCDs (Hole Accumulated Diode), each has 659 (H) x 494 (V), (4 : 3) effective picture elements. This results in a high sensitivity of F5.6 at 2000 lx and a drastic reduction in vertical smear. With the high packing density of these CCD image sensors and their accurate Spacial Offsetting, the horizontal resolution of 700TV lines is achieved, while 480TV lines of vertical resolution is being attained. In addition, Sony's HAD sensor™ technology reduces dark current noise to provide an excellent signal-to-noise ratio of 58dB.

Furthermore, Detail and Master Pedestal control functions are provided so that sharpness and darkness can be manually adjusted based on users' requirements.

Alternative White Balance Control Modes

The DXC-9000 has three types of white balance control modes - AWB, ATW and Manual (R/B Gain) - to meet a wide range of operational conditions. An R/B Paint function is also provided to manually trim the AWB and ATW settings.

AWB (Auto White Balance):

automatically memorizes the adjusted white balance value.

ATW (Auto Tracing White Balance):

adjusts the white balance automatically in response to varying light conditions. This mode is used when the light source changes.

Manual (R/B Gain):

White balance can be manually adjusted using the red and blue gain level controls.

R/B Paint:

Starting from the value set by AWB or ATW, red and blue gain can be finely adjusted.

Variable Speed Electronic Shutter

Nine-step Shutter Speed Selection

1/60, 1/100 (flickerless mode), 1/125, 1/250, 1/500, 1/1000, 1/2000, 1/4000, 1/10000 (seconds)

Clear Scan™ Function (1H step selection)

This function is useful to shoot computer displays without horizontal bands appearing across the display screen. Shutter speeds can be finely adjusted from 262/525 to 1/525H in 1H steps or by nine-step speed selection. To use the Clear Scan function, match the DXC-9000 shutter speed with the scanning frequency of the computer display.

External Trigger Shutter

The external trigger shutter can be activated by receiving a trigger pulse from external equipment. Compared to a conventional nine-step speed shutter, this feature offers a high-precision start along with control of the exposure time.

CCD IRIS™ and AGC (Auto Gain Control) Functions - for a wide range of incoming light levels

The CCD IRIS function automatically reduces the camera exposure time by changing the electronic shutter speed when the incident light level exceeds the auto iris adjustment range. This function is equivalent to a four F-stop decrease sensitivity. On the other hand, the AGC circuit can automatically boost its video gain up to 8 times after the lens iris is fully open, under inadequately low light conditions. This is equivalent to an increase of a three F-stop in sensitivity. By operating these functions and the

AUTO IRIS function together, an even wider range of incoming light levels can be automatically accommodated.

These functions are particularly effective in microscope applications because it eliminates the use of an expensive microscope adaptor with auto iris control.

Three-pattern Light Metering System with Selectable Detection Area

Combining AGC, CCD IRIS and an auto-iris lens is an effective way of using automatic light adjustments in microscope applications.

Even when the background is much brighter or darker than the subject in the center, automatic light adjustments are executed based on the average of the brightness of the whole picture. With the DXC-9000's light metering system, three sizes of windows - Large (75%), Medium (50%) and Spot (25%) - detect the brightness. The luminance level detection method - Average or Peak - can also be chosen according to the size and lighting condition of the object. Therefore, the DXC-9000 can highlight specific images and perform automatic light adjustment based on the luminance level of the brightness in the selected window.

On-screen Menu

Easy and quick settings are possible with the MENU/FUNCTION/DATA buttons on the camera's rear panel or by using the optional RM-C950 Remote Control Unit. The function menu is displayed on a monitor by Y/C, RGB or composite video signal outputs. The menu screens are divided into four groups according to their purpose. The User Preset and Memory Protect functions are provided to store and lock two sets of set-up parameters from the menu screen.

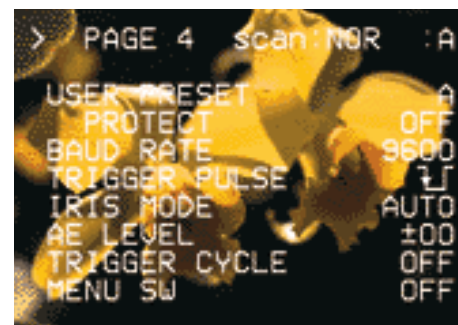

Built-in RS-232C

The DXC-9000 is equipped with an 8-pin RS-232C interface, allowing the camera to be remotely controlled from external equipment such as a personal computer.



Other Convenient Features

Compact and Lightweight

Innovative Sony mechanical and electronic advances make the DXC-9000 remarkably compact and lightweight, featuring superior durability and reliability. This enables the camera to be easily installed almost anywhere.

Multiple Output Signals

In addition to a BNC connector providing a composite signal output, the DXC-9000 has a 9-pin D-sub output connector for RGB signals. A Y/C or a VBS signal is also available from this connector and can be selected. In addition, a sync signal can be added onto the G output signal when using RGB output.

Genlock Capability

The DXC-9000 can be synchronized with a VBS or a BS signal from other equipment and includes an SC/H phase adjustment control. HD/VD sync signals also can be accepted.

Color Bar Generator

Full color bars (Full field) can be generated as a test signal source for system and monitor adjustment by just pushing the button on the camera's rear panel or the optional RM-C950 Remote Control Unit.

Bayonet Mount Lens Adoption (A dual hot-shoe connection)

The DXC-9000 is designed to accept 1/2-inch, 38mm bayonet-mount lenses. A dual hot-shoe connection is also

provided to eliminate the need of a lens-to-camera interconnecting cable, providing easy remote control of zoom, focus and iris functions. This improves the reliability of the connection and simplifies lens interchange. 2/3-inch mount lenses can also be used by connecting the optional LO-32BMT Lens Mount Adaptor.



What is a Progressive Scan CCD? Why was a Progressive Scan CCD invented?

With a conventional CCD image sensor, the vertical resolution was only about 350TV lines because it used the field integration technique to match NTSC broadcasting specifications. This was the result of the NTSC standard, which used two fields, each of 262.5 scanning lines, interlaced at 2:1 to create a single frame. Since emphasis was placed on making the motion of a subject appear smooth rather than providing a high vertical resolution, the conventional CCD (IS-IT structure) mixed the signal charges from two adjacent pixels vertically, outputting 262.5 line signals per field (i.e., per single exposure).

In applications such as image measurement, image processing and still imagery, the vertical resolution is still insufficient compared to horizontal resolution.

To resolve this problem, Sony developed a Progressive Scan CCD image sensor, which does not mix signals in the vertical CCD.

How does a Progressive Scan CCD read out?

The table on the right is a comparison of the Progressive Scan method and conventional methods.



The Progressive Scan method can read out the information from each pixel individually in a single field (1/60s), providing both high vertical resolution and high dynamic resolution.

	Progressive Scan method	Conventional Method	
		Field integration method	Frame integration method
First field (Odd)			
Second field (Even)			
Features	High vertical resolution High dynamic resolution	Low vertical resolution High dynamic resolution	High vertical resolution Low dynamic resolution

The following figures show differences in output for three different readout methods, when using moving objects.

Still Image Capture
Three Different Methods
(in case a moving subject is shot)

- Conventional CCD (Frame integration mode)
 

Odd field
- Conventional CCD (Field integration mode)
 
- Progressive Scan CCD (DXC-9000, frame shutter mode)
 

Even field

The Progressive Scan method can obtain signals generated during a single exposure period from each pixel. This means that it is possible to obtain image signals delivering both high vertical resolution and high dynamic resolution without a mechanical shutter, which is impossible with a conventional CCD. As a result, a Progressive Scan CCD is optimum for use in applications where rapidly-moving objects must be captured with high resolution, such as in image measurement and image processing fields.

Function Menu

Control items	Selection
PAGE 1	
GAIN	AGC/STEP
STEP	0-18dB
SHUTTER	
STEP	(High-speed mode) $\frac{1}{60}$, FL ($\frac{1}{100}$), $\frac{1}{125}$, $\frac{1}{250}$, $\frac{1}{500}$, $\frac{1}{1000}$, $\frac{1}{2000}$, $\frac{1}{4000}$, $\frac{1}{8000}$, $\frac{1}{10000}$ (seconds) (Long-term exposure mode) 0.1, 0.2, 0.3, 0.5, 1.0, 1.5, 2.0, 2.5, 3.0, 3.5, 4.0, 5.0, 6.0, 7.0, 8.0 sec.
VARIABLE	(Long-term exposure mode) 1 to 255FRM (Clear Scan mode) 262/525 to 1/525H
EXT. TRIGGER	ON/OFF
AE WINDOW	LARGE/MEDIUM/SPOT
DETECTION	PEAK/AVERAGE
PAGE 2	
C. TEMP	AUTO/3200K/5600K
WHT. BAL	AWB/MANU/ATW
AUTO R Paint	- 10 to 0 to + 10
AUTO B Paint	- 10 to 0 to + 10
MANU R Gain	- 127 to 0 to +127
MANU B Gain	- 127 to 0 to +127
M. PEDESTAL	- 99 to 0 to + 99
GAMMA	ON/OFF
DETAIL	ON/OFF
LEVEL	- 99 to 0 to + 99
PAGE 3	
H. PHASE	- 99 to 0 to + 99
SC PHASE Rough	0/180
SC PHASE Fine	- 99 to 0 to +99
G SYNC	ON/OFF
D-SUB Video	VBS/YC/VD
D-SUB Sync	WEN/C. SYNC/HD
EXT. CTRL (BNC)	GENLOCK/TRIG. IN
FREEZE	INT. CTRL/EXT. CTRL
MODE	F/F, F/S
PAGE 4	
USER PRESET	A/B
PROTECT	ON/OFF
BAUD RATE	9600/4800/2400/1200
TRIGGER PULSE	
IRIS MODE	FIX/AUTO
AE LEVEL	- 30 to 0 to +30
TRIGGER CYCLE	OFF, 2-FRM to 10 min
MENU SW	ON/OFF

DXC-9000 Rear Panel & Side Panel

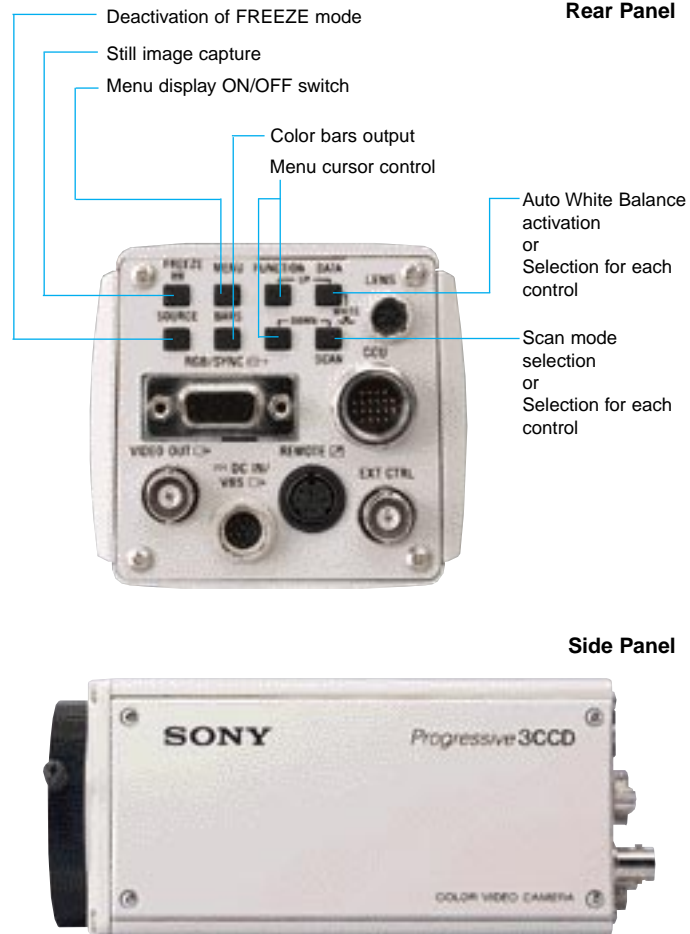

Optional Accessories

Remote Control Unit **RM-C950**



Note: New labels for the FREEZE, SCAN, and SHUTTER SPEED buttons are supplied with the DXC-9000.

The RM-C950 can remotely control all functions of the DXC-9000, along with zoom, focus and iris functions by using an 8-pin connector through the REMOTE (RS-232C) interface on the camera's rear panel. The camera functions in frequent use such as Gain, Detail, Master Pedestal and Red and Blue gain are easily controlled simply by turning a knob (there is no need to display the menu screen on a monitor). The RM-C950 is particularly useful in microscope applications because the operator can adjust the image while concentrating on the picture. The freeze button is also provided, so that a still image of a moving object can be easily captured. The shutter speed used in the high-speed mode and the long-term exposure mode can be adjusted with the UP and DOWN buttons.

Specifications

Connector:	REMOTE (8-pin)
Operating temperature:	-5°C to 45°C (23°F to 113°F)
Power requirements:	DC 12V
Mass:	Approx. 400g (14 oz)
Dimensions:	212 (W) x 41 (H) x 132 (D)mm (8 3/8 x 1 5/8 x 5 1/4 inches) (excluding projecting parts and controls)
Supplied accessories:	Connection cable (3m) Operation manual

Camera Adaptor **CMA-D2**

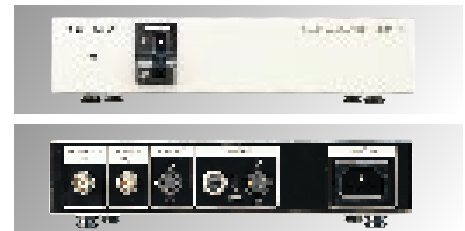

The CMA-D2 supplies DC 12V to the DXC-9000. When the CMA-D2 is directly connected to the DXC-9000, a cable extension of up to 100m is possible.

Specifications

Connectors:	CAMERA (12-pin MULTI) CAMERA (4-pin DIN) VIDEO OUT (BNC) S VIDEO OUT (Mini DIN 4-pin) GENLOCK IN (BNC)
DC out:	13V, 1.3A
Operating temperature:	-5°C to 45°C (23°F to 113°F)
Power requirements:	AC 100 to 240V, 50/60Hz
Power consumption:	24.5W
Dimensions:	210 (W) x 44 (H) x 200 (D) mm (8 3/8 x 1 3/4 x 7 7/8 inches) (excluding projecting parts)
Mass:	1.1kg (2 lb 7 oz)
Supplied accessories:	AC power cord Operation manual



Models	VCL-707BXM	VCL-712BXEA	VCL-714BXEA	VCL-716BXEA	YH17x7 KTS B (by Canon)
Mount	Boyonet	Boyonet	Boyonet	Boyonet	Boyonet
Focal length	7.5-52.5mm	7.5-90mm	7.5-105mm	7-112mm	7-119mm
Zoom ratio	7 x	12 x	14 x	16 x	17 x
Zoom control	Manual	Remote	Remote	Remote	Remote
Focus control	Manual	Remote	Remote	Remote	Remote
Iris control	Manual	Remote	Remote	Remote	Remote
Maximum aperture ratio	1 : 1.6	1 : 1.4	1 : 1.4	1 : 1.4	1 : 1.4
Minimum object distance	0.3m	1.1m	1.1m	1.0m	0.95mm
Macro	Not applicable	Applicable	Applicable	Applicable	Applicable
Filter size	M58 x 0.75mm	M72 x 0.75mm	M72 x 0.75mm	M86 x 1.0mm	M82 x 0.75mm
Mass	560 g (1 lb 4 oz)	1.25 kg (2 lb 12 oz)	1.13 kg (2 lb 6 oz)	1.8 kg (3 lb 15 oz)	1.7 kg (3 lb 12 oz)
Dimensions	60 (dia.) x 125 (L)mm (2 3/8 x 5 inches)	110 (dia.) x 184.2 (L)mm (4 3/8 x 7 3/8 inches)	110 (dia.) x 185.9 (L)mm (4 3/8 x 7 3/8 inches)	120.5 (W) x 100 (H) x 178 (D)mm (4 3/4 x 4 x 7 1/8 inches)	128(W) x 97.5(H) x 168.9(L)mm (5 1/8 x 3 7/8 x 6 3/4 inches)
Notes	-	Zoom/Focus/Iris functions can be remotely controlled from the RM-C950.			

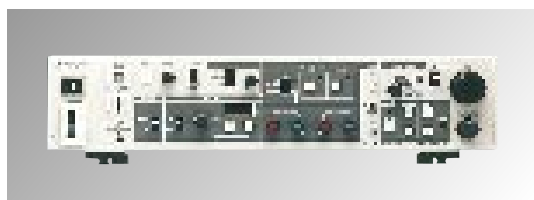

Camera Control Unit
CCU-M5



Microscope Adaptor with
Auto Iris
MVA-40



Microscope Adaptor
MVA-41A



Coupler for NIKON X/Y
Series Microscopes
MVAC-33-N



Coupler for OLYMPUS
BH-2/AH Series
Microscopes
MVAC-33-O



Coupler for NIKON
SMZ-10 Series
Microscopes
MVAC-33-SM



2/3-inch Lens Mount
Adaptor
LO-32BMT



DC Cable
CCDC-5/10/25/50A/100A
(5/10/25/50/100m)



12-pin Multi Cable
CCMC-12P02/05/10/25
(2/5/10/25m)

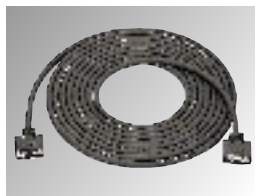

RGB Cable
CCXC-9DD
(5m, 9-pin D-sub ↔ 9-pin D-sub)



RGB Cable
CCXC-9DB
(5m, 9-pin D-sub ↔ BNCs
(R/G/B/SYNC/VBS))



RGB Cable
CCMC-9DS
(5m, 9-pin D-sub ↔ BNCs
(R/G/B/SYNC), DIN 4-pin (Y/C))

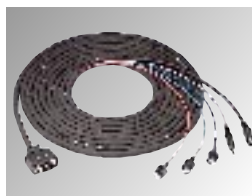

RGB Cable
CCMC-9DSMN
(5m, 9-pin D-sub ↔ BNCs (R/G/B),
Audio Mini Jack (SYNC), DIN 4-pin
(Y/C))

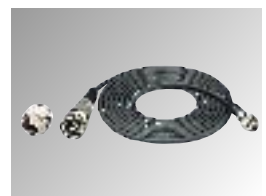

Camera Cable
CCTZ-3RGB
(3m, RGB/VBS out for CCU-M5
connection, CCZZ-1E
interconnection adaptor is
supplied)



Camera Cable
CCTZ-3YC
(3m, YC/VBS out for CCU-M5
connection, CCZZ-1E
interconnection adaptor is
supplied)



Camera Cable
CCTQ-3RGB
(3m, RGB/VBS out for CCU-M5
connection, CCQQ-1
interconnection adaptor is
supplied)

System Connections

Example 1. Computer Image Processing Operation

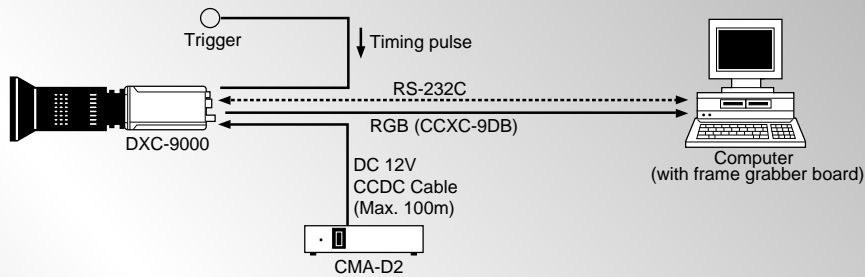

Example 2. Video Microscope Operation

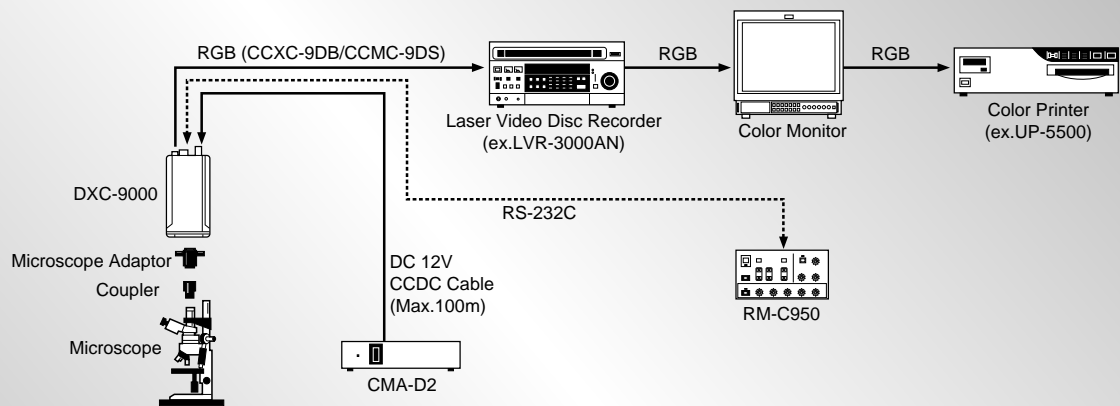

Example 3. Projection Operation

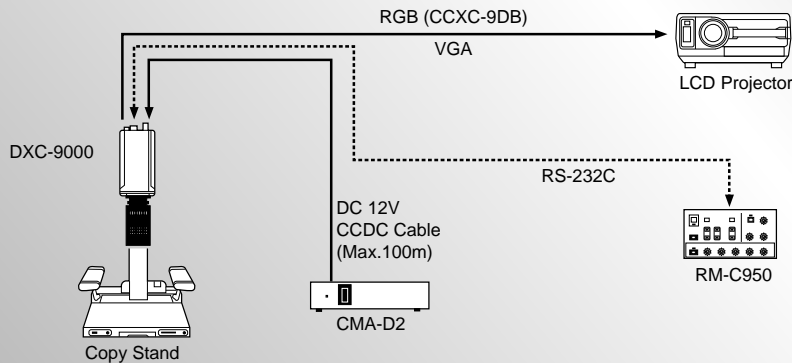

Example 4. Remote Control Operation

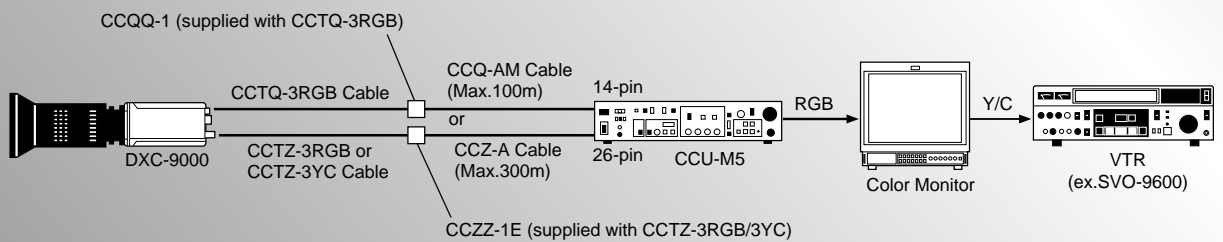

Specifications

Image device:	1/2-inch Interline Transfer Hyper HAD CCD (x3)
Picture elements:	659(H) x 494(V)
Sensing area:	6.4 x 4.8mm
Signal format:	NTSC standard format: 2 : 1 interlaced, 525 lines VGA format: Non-interlaced, 640 x 480, 1/60
Horizontal frequency:	NTSC standard format: 15.734kHz VGA format: 31.469kHz
Vertical frequency:	NTSC standard format: 59.94Hz VGA format: 59.94Hz
Sync system:	Internal or external with VBS, BS, VS, SYNC or HD/VD
Phase control:	H (-99 to 0 to +99)/SC (0/180, -99 to 0 to +99)
Green-on-sync:	ON/OFF switchable
Resolution:	Horizontal: 700TV lines Vertical: 480TV lines
Lens mount:	1/2-inch, 38mm bayonet
Sensitivity:	F5.6 at 2,000 lx (3200K)
Minimum illumination:	15 lx (F1.4, Gain: 18dB)
Signal-to-noise ratio:	58dB
Gain control:	AGC/0~18dB (1dB steps)
Electronic shutter:	OFF/STEP/VARIABLE/CCD IRIS STEP: $1/60, 1/100$ (Flickerless mode), $1/125, 1/250, 1/500, 1/1000, 1/2000, 1/4000, 1/10000$ (seconds) 0.1, 0.2, 0.3, 0.5, 1.0, 1.5, 2.0, 2.5, 3.0, 3.5, 4.0, 5.0, 6.0, 7.0, 8.0 (seconds) VARIABLE: 255 to 1 frame, 262/525 to 1/525H
External trigger shutter:	ON/OFF switchable
Freeze control:	INT. CTRL/EXT. CTRL switchable
AE Window:	Large/Medium/Spot (Peak/average switchable)
Color temperature:	3200K/5600K
White balance:	ATW, AWB (R/B Paint: -10 to 0 to +10) MANU (R/B Gain: -127 to 0 to +127) -99 to 0 to +99
Master pedestal:	On/OFF switchable (-99 to 0 to +99)
Detail:	ON/OFF switchable
Gamma:	ON/OFF switchable
User preset:	A/B switchable
User protect:	ON/OFF switchable
Baud rate:	9600, 4800, 2400, 1200
Trigger pulse:	Negative pulse/Positive pulse switchable
Video out:	VBS: 1.0Vp-p, 75Ω, sync negative RGB: 0.7Vp-p, 75Ω Y/C: Y: 1.0Vp-p, 75Ω, sync negative C: 0.286Vp-p, 75Ω, without sync VGA, RGB: 0.7Vp-p, 75Ω SYNC/HD/VD: 2Vp-p, 75Ω WEN: 5Vp-p, high impedance
External sync input:	VBS/BS/VS/SYNC/HD/VD (VBS 1.0Vp-p or burst 0.3Vp-p, SYNC 0.3Vp-p, HD/VD: 2.0~4.0Vp-p), 75Ω
External trigger input:	Trigger pulse, low level: 0 to 0.5V, high level: 4.5 to 5.0V, high impedance
Operating temperature:	-5°C to 45°C (23°F to 113°F)
Storage temperature:	-20°C to 60°C (-4°F to 140°F)
Power requirements:	DC 12V (supplied from CMA-D2 or CCU-M5)
Power consumption:	Approx. 11.5W
Mass:	Approx. 790g (1 lb 11 oz)
Connectors:	LENS (6-pin), RGB/SYNC (D-sub 9-pin), DC IN/VBS (12-pin), VIDEO OUT (BNC), CCU (20-pin), REMOTE (8-pin), EXT CTRL (BNC), HOT SHOE (14-pin)
Supplied accessories:	Lens mount cap, Buttons label for the optional RM-C950 Remote Control Unit, Operation manual
Dimensions:	

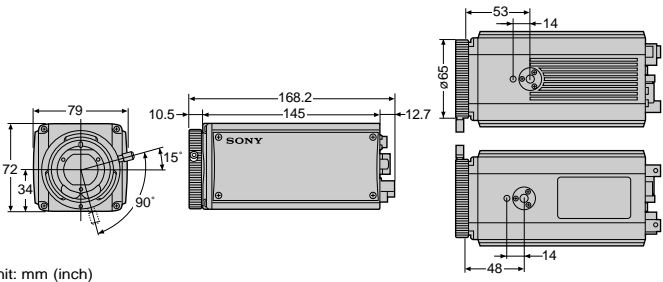

DXC-9000 Connector's Pin Assignments

6-pin (LENS)

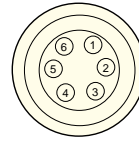

1	-
2	(G)
3	DC IN (G)
4	IRIS CLOSE
5	IRIS CONT
6	DC IN (+)

8-pin (REMOTE)

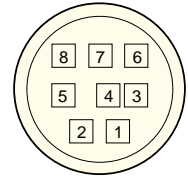

1	INTER CONNECT
2	INTER CONNECT
3	DATA OUT
4	DC OUT (G)
5	DATA IN
6	NC
7	DC OUT (+)
8	NC

D-sub 9-pin (RGB/SYNC)

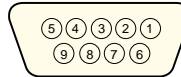

1	VBS/Y/C (G)
2	RGB (G)
3	R (X)
4	G (X)
5	B (X)
6	VBS/Y/-VD (X)
7	SYNC/HD/WEN (X)
8	SYNC (G)
9	-/C(X)

12-pin (DC IN/VBS)

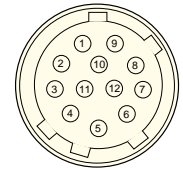

1	DC IN (G)
2	DC IN (+)
3	VBS/Y (G)
4	VBS/Y (X)
5	-/EXT HD (G)
6	-/EXT HD (X)
7	EXT VBS/VD (X)
8	-/C (G)
9	-/C (+)
10	DC IN (G)
11	DC IN (+)
12	EXT VBS/VD (G)

20-pin (CCU)

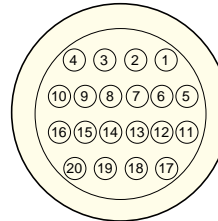

1	DC IN (+)
2	DC IN (G)
3	VBS (X)
4	VBS (G)
5	R (X)
6	R (G)
7	G (X)
8	G (G)
9	B (X)
10	B (G)
11	Y (X)
12	Y (G)
13	C (X)
14	C (G)
15	EXT VBS (X)
16	EXT VBS (G)
17	SERIAL DATA (X)
18	SERIAL DATA (G)
19	SENSE (+)
20	SENSE (-)

14-PIN (HOT SHOE)

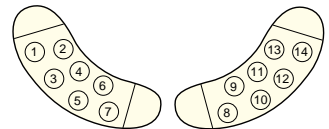

1	NC
2	NC
3	GND
4	IRIS SERVO/ MANUAL CONT
5	IRIS CONT
6	DC 12V
7	NC
8	FOCUS CONT
9	ZOOM CONT
10	NC
11	NC
12	POSITION/SPEED
13	NC
14	NC

Features and specifications subject to change without notice.
"Hyper HAD", "HAD sensor", "CCD IRIS" and "Clear Scan" are trademarks of Sony Corporation.
Sony is a registered trademark of Sony Corporation.



Distributed by

MK4042OHB9610P2-002

Sony Corporation
Printed in Japan © SONY